

Digital Step Attenuator

50Ω DC-2400 MHz

31 dB, 1 dB Step

5 Bit, Serial Control Interface, Single Positive Supply Voltage, +3V

Product Features

- Single positive supply voltage, +3V
- Immune to latch up
- Excellent accuracy, 0.1 dB Typ
- Serial control interface
- Low Insertion Loss
- High IP3, +52 dBm Typ
- Very low DC power consumption
- Excellent return loss, 20 dB Typ
- Small size 4.0 x 4.0 mm

Typical Applications

- Base Station Infrastructure
- Portable Wireless
- CATV & DBS
- MMDS & Wireless LAN
- Wireless Local Loop
- UNII & Hiper LAN
- Power amplifier distortion canceling loops

General Description

The DAT-31-SP is a 50Ω RF digital step attenuator that offers an attenuation range up to 31 dB in 1.0 dB steps. The control is a 5-bit serial interface, operating on a single +3 volt supply. The DAT-31-SP is produced using a unique CMOS process on silicon, offering the performance of GaAs, with the advantages of conventional CMOS devices.

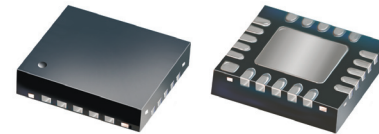

DAT-31-SP+
DAT-31-SP

CASE STYLE: DG983-1
PRICE: \$3.55 ea. QTY. (10-24)

*+ RoHS compliant in accordance
with EU Directive (2002/95/EC)*

*The +Suffix identifies RoHS Compliance. See our web site for
RoHS Compliance methodologies and qualifications.*

Simplified Schematic

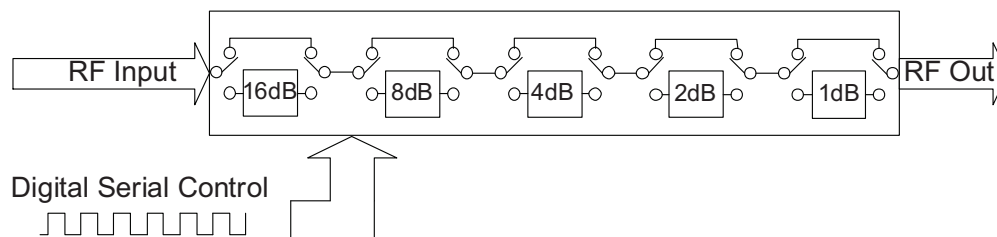

Mini-Circuits®
ISO 9001 ISO 14001 AS 9100 CERTIFIED

P.O. Box 350166, Brooklyn, New York 11235-0003 (718) 934-4500 Fax (718) 332-4661

The Design Engineers Search Engine



Provides ACTUAL Data Instantly at minicircuits.com

For detailed performance specs
& shopping online see web site

Notes: 1. Performance and quality attributes and conditions not expressly stated in this specification sheet are intended to be excluded and do not form a part of this specification sheet. 2. Electrical specifications and performance data contained herein are based on Mini-Circuit's applicable established test performance criteria and measurement instructions. 3. The parts covered by this specification sheet are subject to Mini-Circuits standard limited warranty and terms and conditions (collectively, "Standard Terms"); Purchasers of this part are entitled to the rights and benefits contained therein. For a full statement of the Standard Terms and the exclusive rights and remedies thereunder, please visit Mini-Circuits' website at www.minicircuits.com/MCLStore/terms.jsp.

REV. F
M126943
DAT-31-SP
100411
Page 1 of 12

RF Electrical Specifications, DC-2400 MHz, $T_{AMB}=25^{\circ}C$, $V_{DD}=+3V$

Parameter	Freq. Range (GHz)	Min.	Typ.	Max.	Units
Accuracy @ 1 dB Attenuation Setting	DC-1	—	0.02	0.1	dB
	1-2.4	—	0.05	0.15	dB
Accuracy @ 2 dB Attenuation Setting	DC-1	—	0.05	0.15	dB
	1-2.4	—	0.15	0.25	dB
Accuracy @ 4 dB Attenuation Setting	DC-1	—	0.07	0.2	dB
	1-2.4	—	0.15	0.25	dB
Accuracy @ 8 dB Attenuation Setting	DC-1	—	0.03	0.2	dB
	1-2.4	—	0.15	0.25	dB
Accuracy @ 16 dB Attenuation Setting	DC-1	—	0.1	0.3	dB
	1-2.4	—	0.15	0.3	dB
Insertion Loss ^(note1) @ all attenuator set to 0dB	DC-1	—	1.3	1.9	dB
	1-2.4	—	1.6	2.4	dB
Input IP3 ^(note 2) (at Min. and Max. Attenuation)	DC-2.4	—	+52	—	dBm
Input Power @ 0.2dB Compression ^(note 2) (at Min. and Max. Attenuation)	DC-2.4	—	+24	—	dBm
VSWR	DC-1	—	1.2	1.5	—
	1-2.4	—	1.2	1.5	—

Notes:

- Loss values are de-embedded from test board Loss (test board's Insertion Loss: 0.10dB @100MHz, 0.35dB @1000MHz, 0.60dB @2400MHz, 0.75dB @4000MHz)
- Input IP3 and 1dB compression degrades below 1 MHz

DC Electrical Specifications

Parameter	Min.	Typ.	Max.	Units
V_{DD} , Supply Voltage	2.7	3	3.3	V
I_{DD} , Supply Current	—	—	100	μA
Control Input Low	—	—	$0.3 \times V_{DD}$	V
Control Input High	$0.7 \times V_{DD}$	—	—	V
Control Current	—	—	1	μA

Switching Specifications

Parameter	Min.	Typ.	Max.	Units
Switching Speed, 50% Control to 0.5dB of Attenuation Value	—	1.0	—	μSec
Switching Control Frequency	—	—	25	KHz

Absolute Maximum Ratings

Parameter	Ratings
Operating Temperature	-40°C to 85°C
Storage Temperature	-55°C to 100°C
V_{DD}	-0.3V Min., 4V Max.
Voltage on any input	-0.3V Min., $V_{DD}+0.3V$ Max.
ESD, HBM	500V
ESD, MM	100V
Input Power	+24dBm

Permanent damage may occur if any of these limits are exceeded.

Pin Description

Function	Pin Number	Description
C16	1	Control for Attenuation bit, 16dB (Notes 3,4)
RF in	2	RF in port (Note 1)
Data	3	Serial Interface data input (Note 3)
Clock	4	Serial Interface clock input
LE	5	Latch Enable Input (Note 2)
V _{DD}	6	Power Supply
N/C	7	Not connected
N/C	8	Not connected
V _{DD}	9	Power Supply
GND	10	Ground connection
GND	11	Ground connection
GND	12	Ground connection
V _{DD}	13	Power Supply
RF out	14	RF out port (Note 1)
C8	15	Control for attenuation bit, 8 dB (Note 4)
C4	16	Control for attenuation bit, 4 dB (Note 4)
C2	17	Control for attenuation bit, 2 dB (Note 4)
GND	18	Ground Connection
C1	19	Control for attenuation bit, 1 dB (Note 4)
N/C	20	Not connected (Note 5)
GND	Paddle	Paddle ground (Note 6)

Notes:

- Both RF ports must be held at 0VDC or DC blocked with an external series capacitor.
- Latch Enable (LE) has an internal 100KΩ resistor to V_{DD}.
- Place a 10KΩ resistor in series, as close to pin as possible to avoid freq. resonance.
- Refer to Power-up Control Settings.
- Place a shunt 10KΩ resistor to GND
- The exposed solder pad on the bottom of the package (See Pin Configuration) must be grounded for proper device operation

Pin Configuration (Top View)

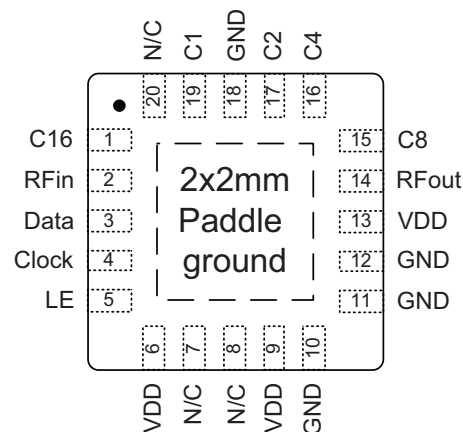

Digital Step Attenuator

DAT-31-SP+
DAT-31-SP

Typical Performance Curves

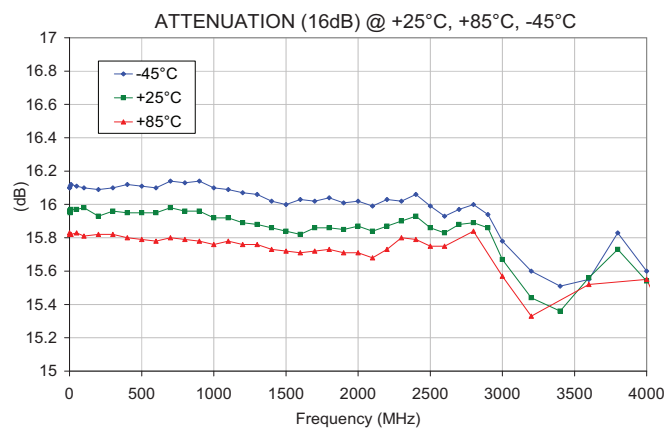
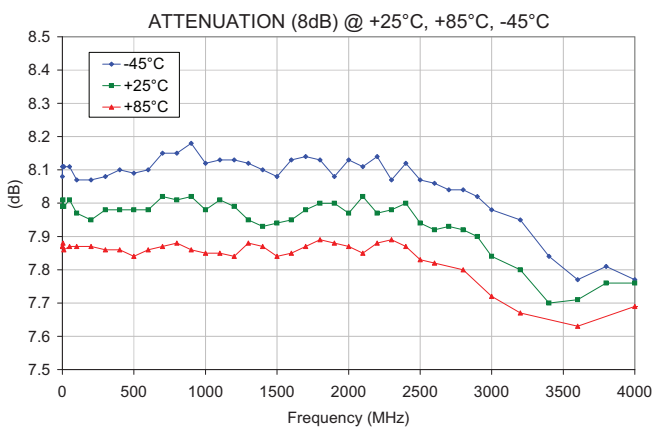
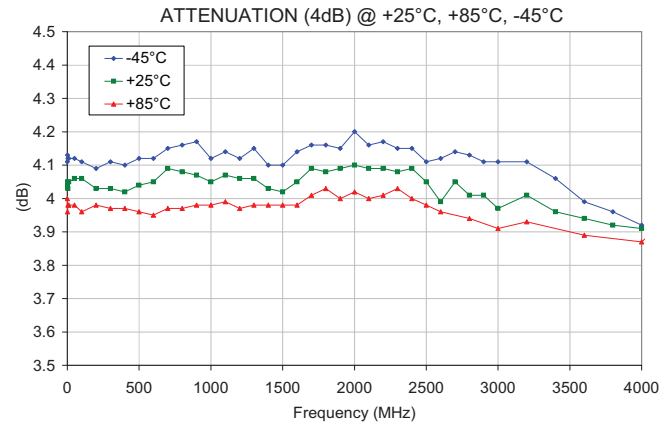
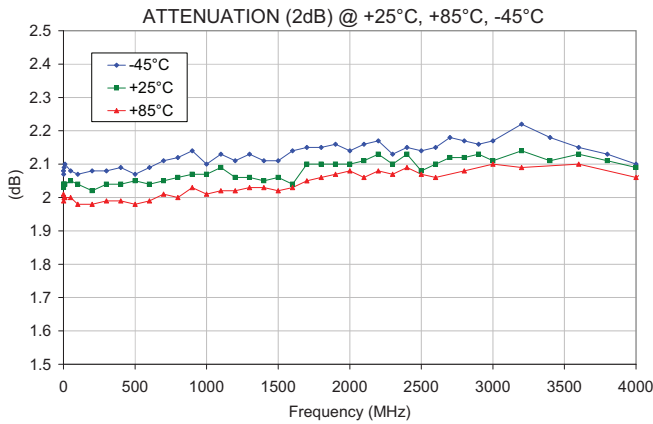
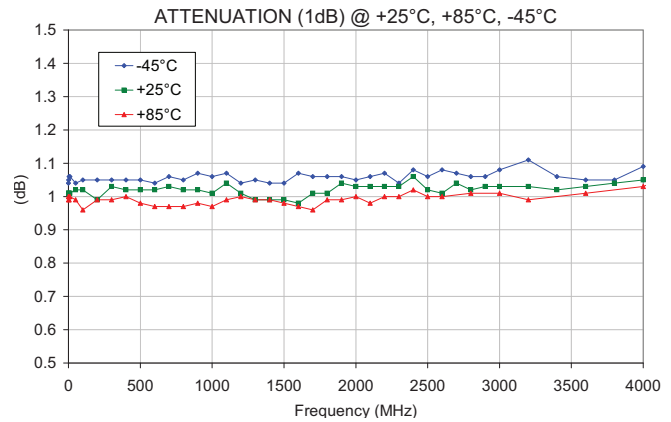
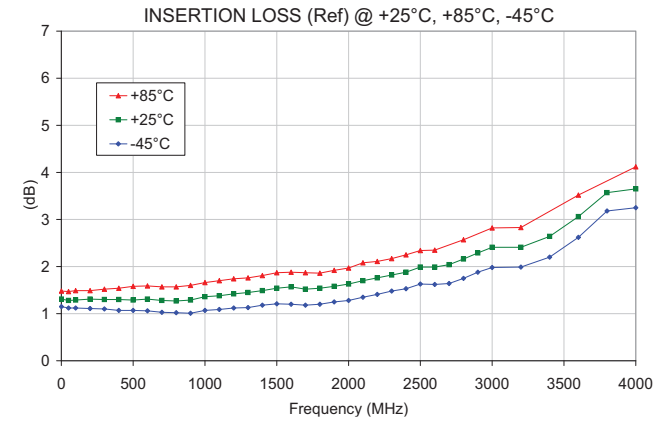

For detailed performance specs & shopping online see web site

P.O. Box 350166, Brooklyn, New York 11235-0003 (718) 934-4500 Fax (718) 332-4661

Notes: 1. Performance and quality attributes and conditions not expressly stated in this specification sheet are intended to be excluded and do not form a part of this specification sheet. 2. Electrical specifications and performance data contained herein are based on Mini-Circuit's applicable established test performance criteria and measurement instructions. 3. The parts covered by this specification sheet are subject to Mini-Circuits standard limited warranty and terms and conditions (collectively, "Standard Terms"); Purchasers of this part are entitled to the rights and benefits contained therein. For a full statement of the Standard Terms and the exclusive rights and remedies thereunder, please visit Mini-Circuits' website at www.minicircuits.com/MCLStore/terms.jsp.

Typical Performance Curves

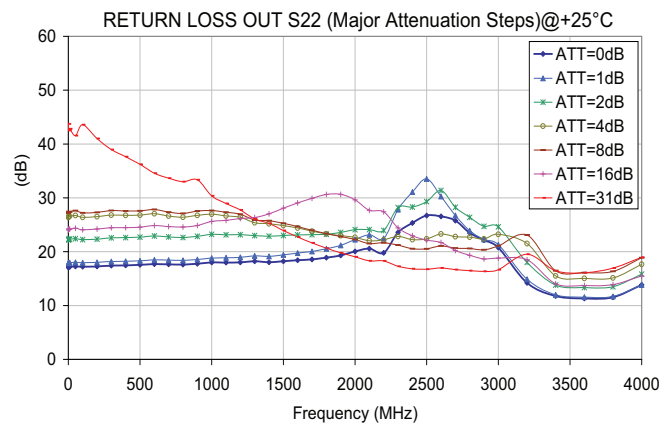
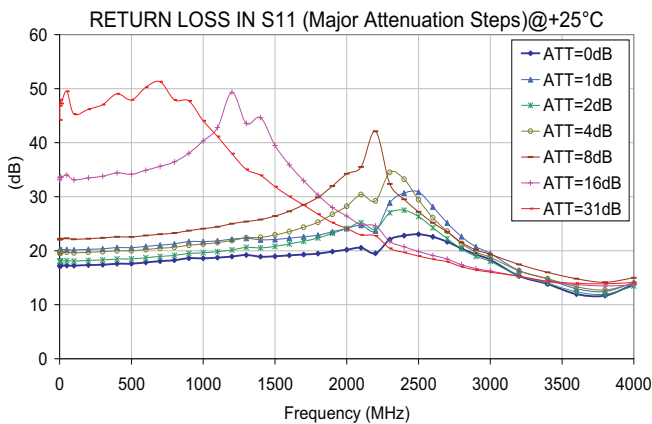
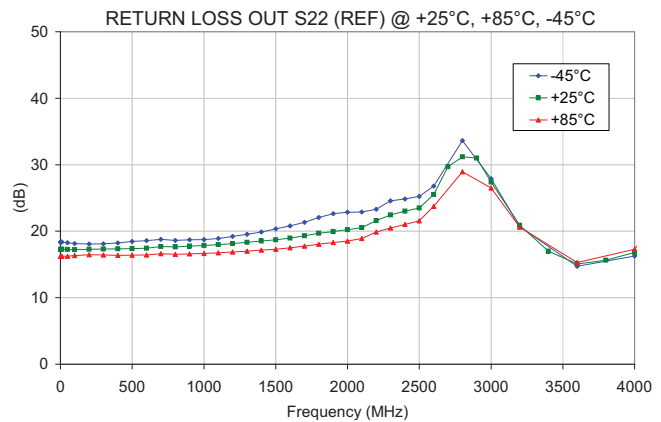
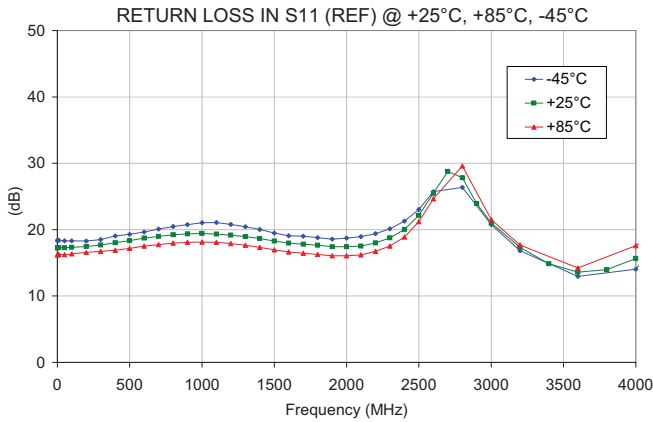
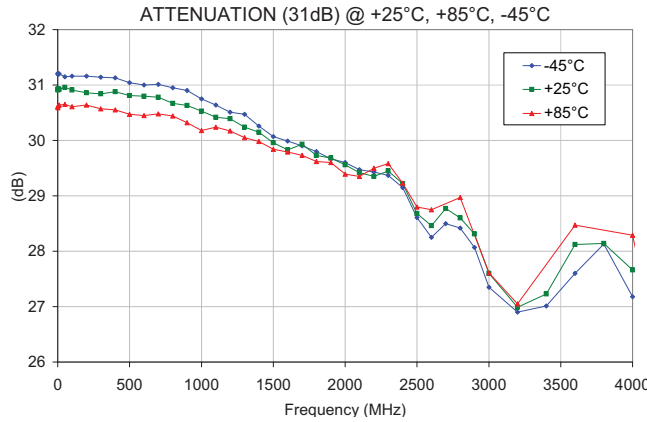

Digital Step Attenuator

DAT-31-SP+
DAT-31-SP

Typical Performance Curves

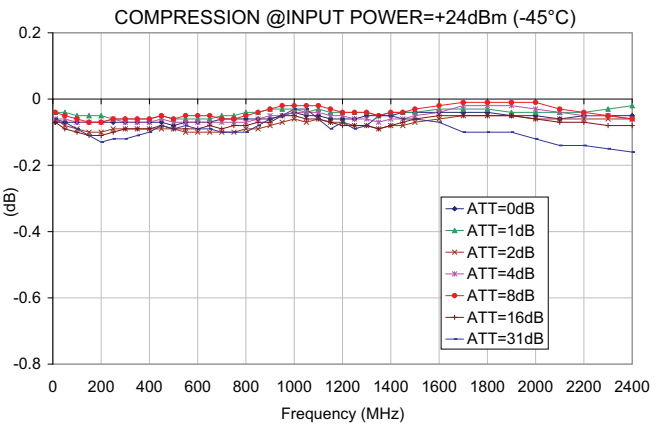
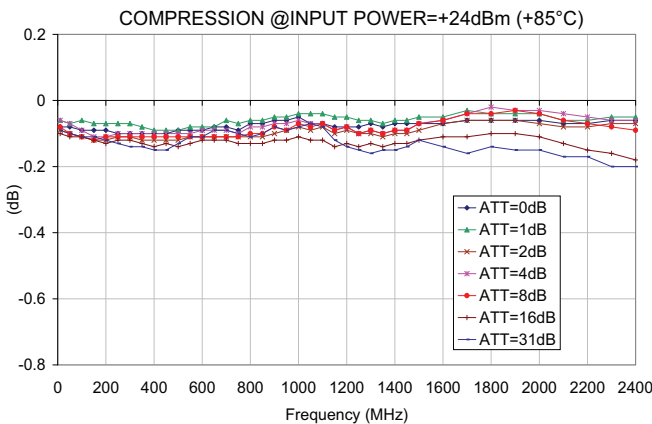
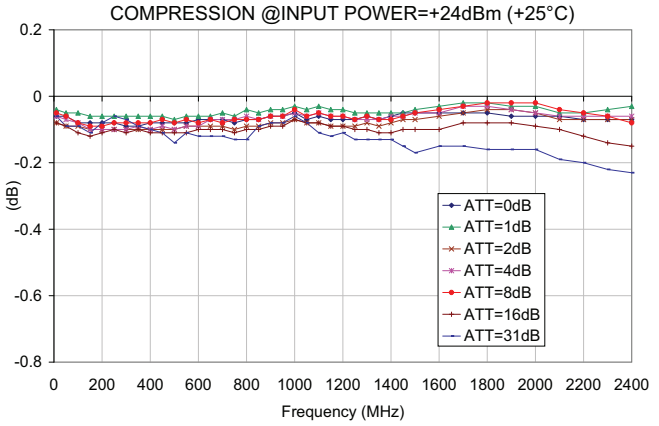
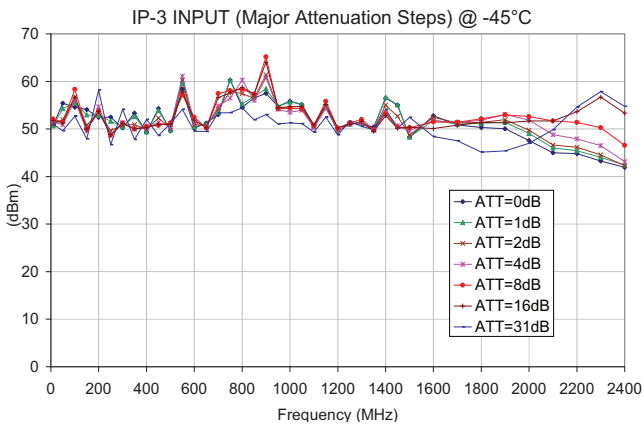
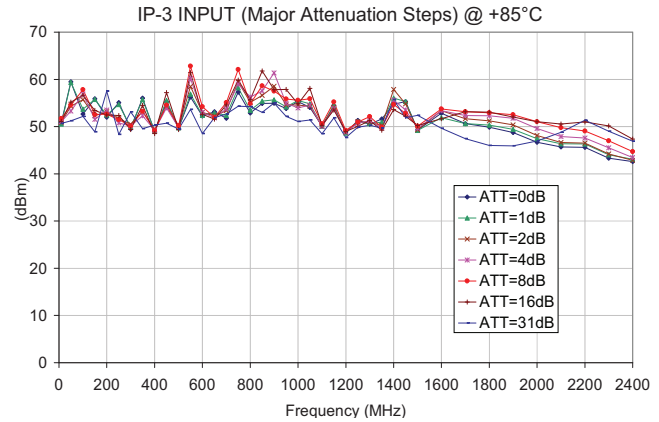
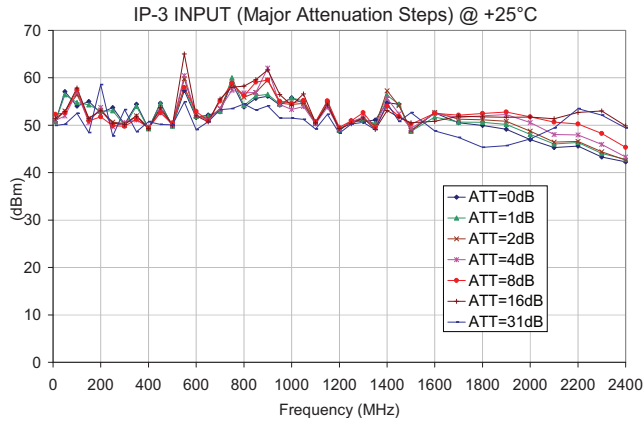

For detailed performance specs & shopping online see web site

P.O. Box 350166, Brooklyn, New York 11235-0003 (718) 934-4500 Fax (718) 332-4661 The Design Engineers Search Engine Provides ACTUAL Data Instantly at minicircuits.com

IF/RF MICROWAVE COMPONENTS

Notes: 1. Performance and quality attributes and conditions not expressly stated in this specification sheet are intended to be excluded and do not form a part of this specification sheet. 2. Electrical specifications and performance data contained herein are based on Mini-Circuit's applicable established test performance criteria and measurement instructions. 3. The parts covered by this specification sheet are subject to Mini-Circuits standard limited warranty and terms and conditions (collectively, "Standard Terms"); Purchasers of this part are entitled to the rights and benefits contained therein. For a full statement of the Standard Terms and the exclusive rights and remedies thereunder, please visit Mini-Circuits' website at www.minicircuits.com/MCLStore/terms.jsp.

Outline Drawing (DG983-1)

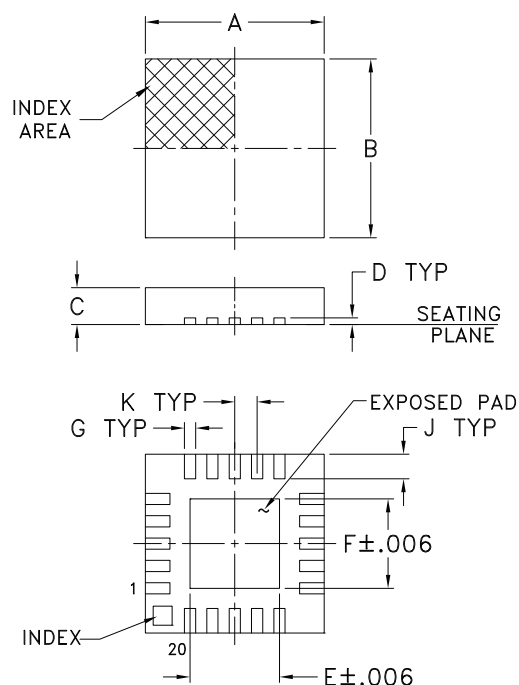

PCB Land Pattern

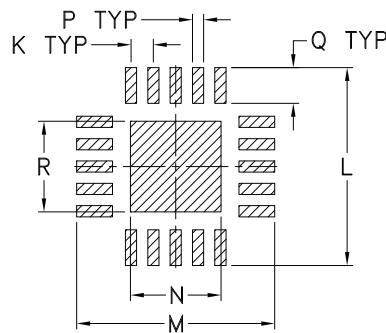

Suggested Layout,
Tolerance to be within ±.002

Device Marking

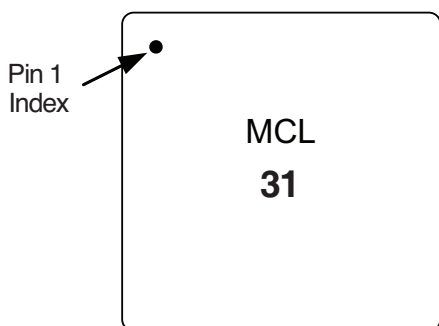

Outline Dimensions (inch/mm)

A	B	C	D	E	F	G	H	J	K	L	M	N	P	Q	R	WT. GRAMS
.157	.157	.035	.008	.081	.081	.010	—	.022	.020	.177	.177	.081	.010	.032	.081	.04
4.00	4.00	0.90	0.20	2.06	2.06	0.25	—	0.56	0.50	4.50	4.50	2.06	0.25	0.81	2.06	

Suggested Layout for PCB Design (PL-191)

The suggested Layout shows only the footprint area of the DAT, and the components located near this area (i.e.: R1-R7). For the complete Layout, see photo and schematic diagram on page 11 of 12.

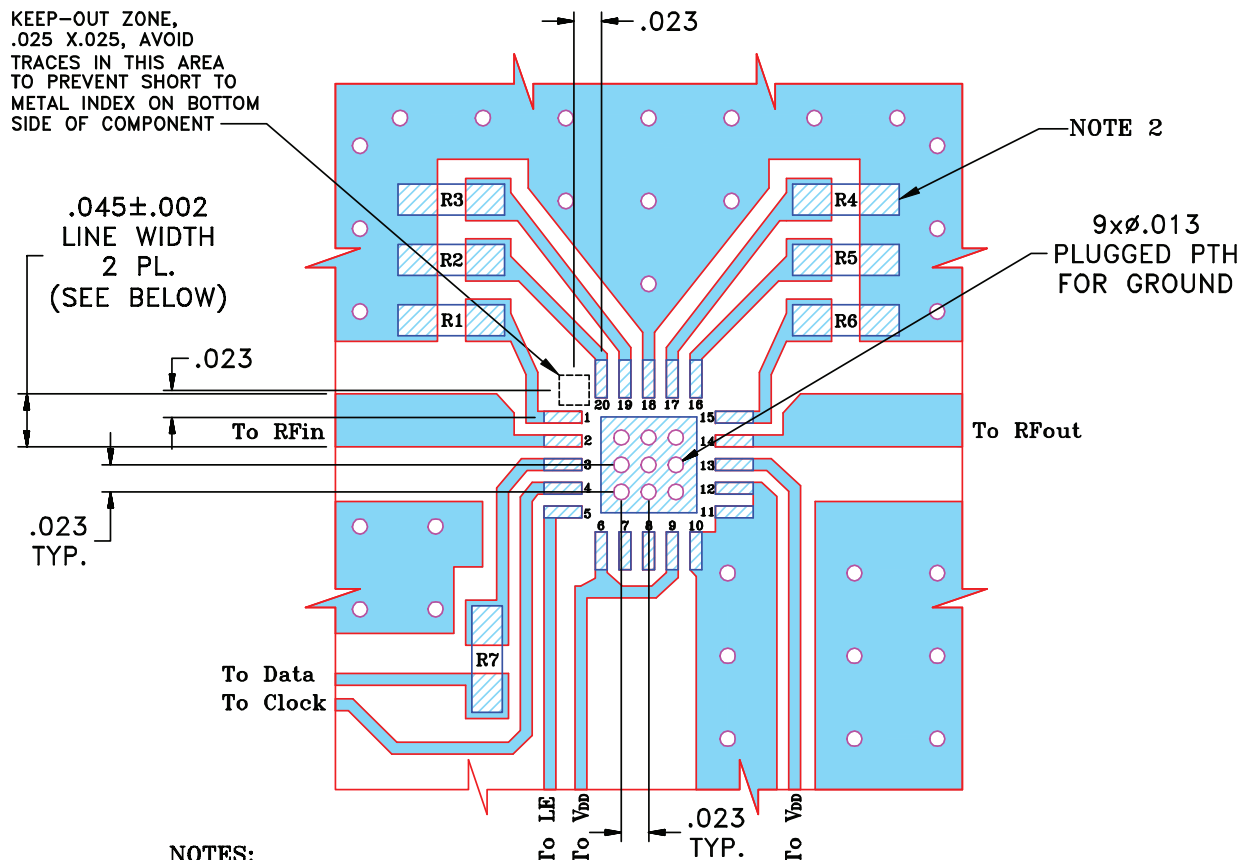

NOTES:

1. TRACE WIDTH IS SHOWN FOR FR4 WITH DIELECTRIC THICKNESS. .025"±.002". COPPER: 1/2 OZ. EACH SIDE. FOR OTHER MATERIALS TRACE WIDTH MAY NEED TO BE MODIFIED.
2. 0603 SIZE CHIP FOOT PRINTS SHOWN FOR REFERENCE, VALUES OF RESISTORS WILL VARY BASED ON APPLICATION.
3. BOTTOM SIDE OF THE PCB IS CONTINUOUS GROUND PLANE.

- DENOTES PCB COPPER LAYOUT WITH SMOBC (SOLDER MASK OVER BARE COPPER)
- DENOTES COPPER LAND PATTERN FREE OF SOLDER MASK

Simplified Schematic

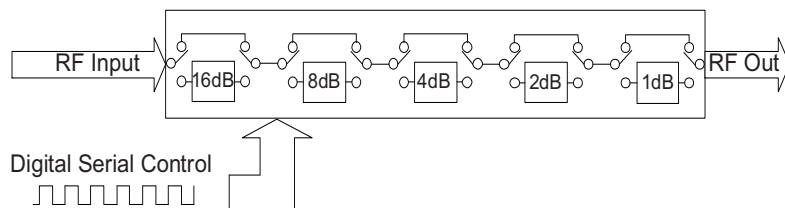

The DAT-31-SP Serial interface consists of 5 control bits that select the desired attenuation state, as shown in Table 1: Truth Table

Attenuation State	C16	C8	C4	C2	C1
Reference	0	0	0	0	0
1 (dB)	0	0	0	0	1
2 (dB)	0	0	0	1	0
4 (dB)	0	0	1	0	0
8 (dB)	0	1	0	0	0
16 (dB)	1	0	0	0	0
31 (dB)	1	1	1	1	1

Note: Not all 32 possible combinations of C1 - C16 are shown in table

The serial interface is a 5-bit serial in, parallel-out shift register buffered by a transparent latch. It is controlled by three CMOS-compatible signals: Data, Clock, and Latch Enable (LE). The Data and Clock inputs allow data to be serially entered into the shift register, a process that is independent of the state of the LE input.

The LE input controls the latch. When LE is HIGH, the latch is transparent and the contents of the serial shift register control the attenuator. When LE is brought LOW, data in the shift register is latched.

The shift register should be loaded while LE is held LOW to prevent the attenuator value from changing as data is entered. The LE input should then be toggled HIGH and brought LOW again, latching the new data. The timing for this operation is defined by Figure 1 (Serial Interface Timing Diagram) and Table 2 (Serial Interface AC Characteristics).

Figure 1: Serial Interface Timing Diagram

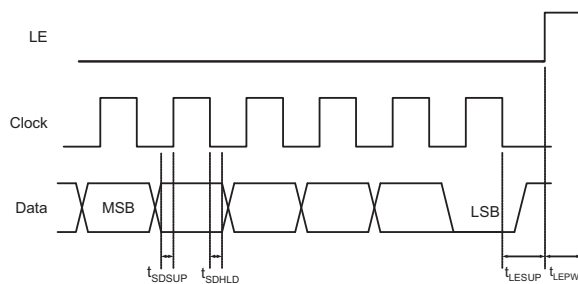

Symbol	Parameter	Min.	Max.	Units
f_{clk}	Serial data clock frequency (Note 1)		10	MHz
t_{clkH}	Serial clock HIGH time	30		ns
t_{clkL}	Serial clock LOW time	30		ns
t_{LESUP}	LE set-up time after last clock falling edge	10		ns
t_{LEPW}	LE minimum pulse width	30		ns
t_{SDSUP}	Serial data set-up time before clock rising edge	10		ns
t_{SDHLD}	Serial data hold time after clock falling edge	10		ns

Note 1. f_{clk} verified during the functional pattern test. Serial programming sections of the functional pattern are clocked at 10MHz to verify f_{clk} specification.

Digital Step Attenuator

The DAT-31-SP, uses a common 5-bit serial word format, as shown in Table 3: 5-Bit attenuator Serial Programming Register Map.

The first bit, the MSB, corresponds to the 16-dB Step and the B1 bit corresponds to the 1 dB step.

B5	B4	B3	B2	B1	B0
C16	C8	C4	C2	C1	0

MSB
(first in)

LSB
(last in)

Note: The stop bit (B0) must always be low to prevent the attenuator from entering an unknown state.

Power-up Control Settings

The DAT-31-SP always assumes a specifiable attenuation setting on power-up, allowing a known attenuation state to be established before an initial serial control word is provided.

When the attenuator powers up, the five control bits are set to whatever data is present on the five data inputs (C1 to C16).

This allows any one of the 32 attenuation settings to be specified as the power-up state.

Digital Step Attenuator

DAT-31-SP+
DAT-31-SP

TB-334 Evaluation Board Schematic Diagram

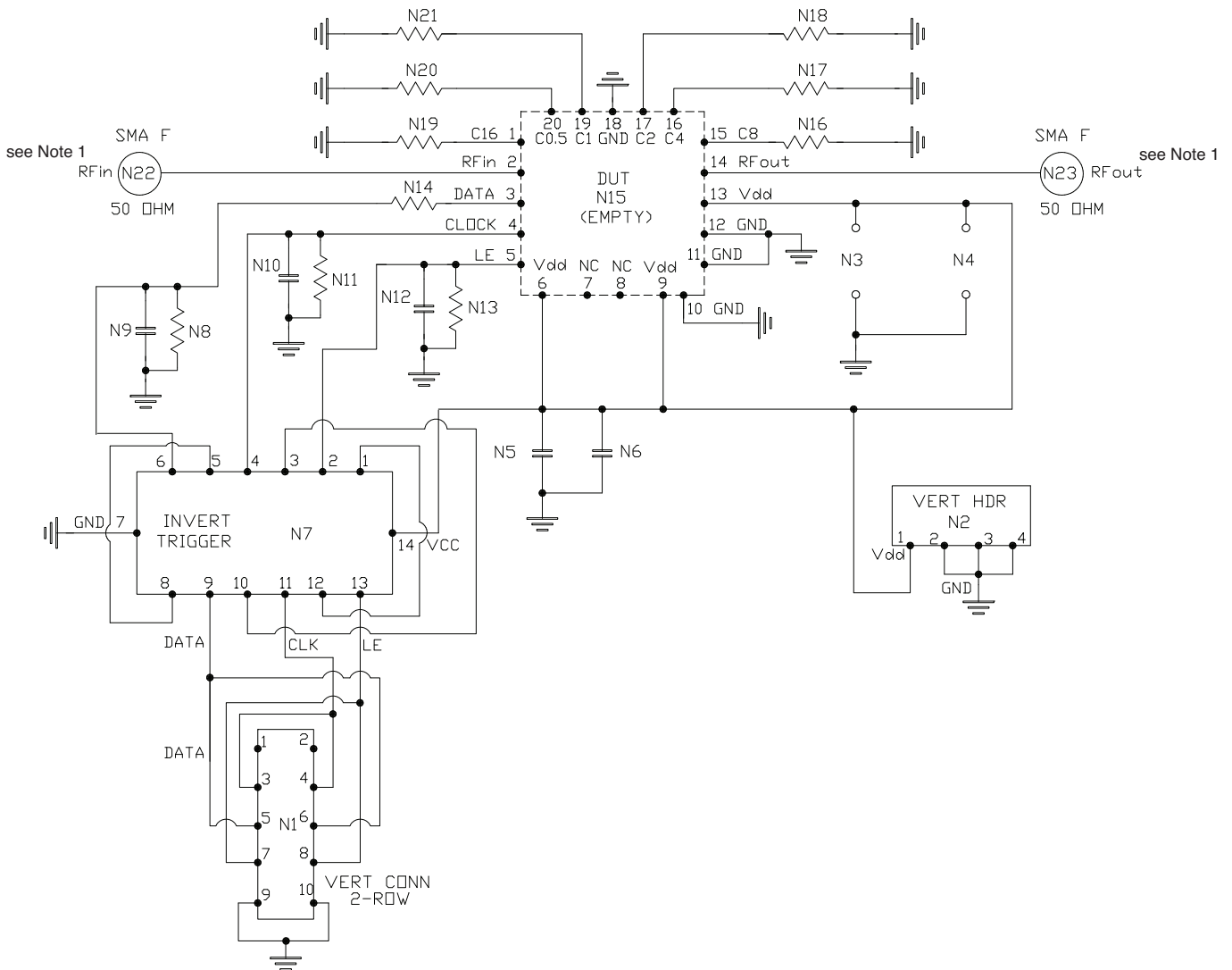

Note 1: Both RF ports must be held at 0VDC or DC blocked with an external series capacitor.

Bill of Materials	
N8, N11, N13, N14, N16-N21	Resistor 0603 10 KOhm +/- 1%
N5, N9, N10 & N12	NPO Capacitor 0603 100pF +/- 5%
N6	Tantalum Capacitor 0805 100nF +/- 10%
N7	Hex Invert Schmitt Trigger MSL1

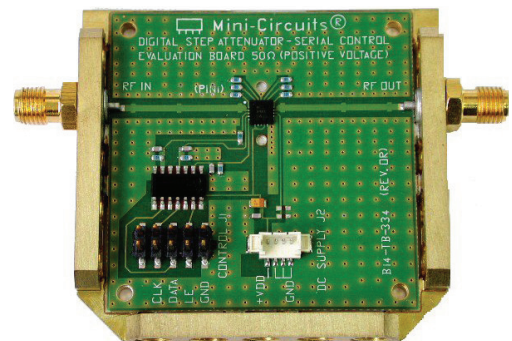

TB-334

Mini-Circuits®
ISO 9001 ISO 14001 AS 9100 CERTIFIED

P.O. Box 350166, Brooklyn, New York 11235-0003 (718) 934-4500 Fax (718) 332-4661 The Design Engineers Search Engine Provides ACTUAL Data Instantly at minicircuits.com

IF/RF MICROWAVE COMPONENTS

For detailed performance specs & shopping online see web site

Notes: 1. Performance and quality attributes and conditions not expressly stated in this specification sheet are intended to be excluded and do not form a part of this specification sheet. 2. Electrical specifications and performance data contained herein are based on Mini-Circuit's applicable established test performance criteria and measurement instructions. 3. The parts covered by this specification sheet are subject to Mini-Circuits standard limited warranty and terms and conditions (collectively, "Standard Terms"); Purchasers of this part are entitled to the rights and benefits contained therein. For a full statement of the Standard Terms and the exclusive rights and remedies thereunder, please visit Mini-Circuits' website at www.minicircuits.com/MCLStore/terms.jsp.

Tape and Reel Packaging Information

Table T&R

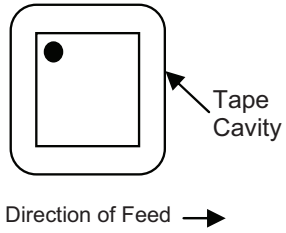
TR No.	No. of Devices	Reel Size	Tape Width	Pitch	Unit Orientation
F87	3000	13 inch	12 mm	8 mm	
	multiples of 10, less than full reel of 3K	13 inch			
	multiples of 10, on tape only	not applicable			

Ordering Information

Model No.	Description	Quantity Min. No. of Units	Price \$ Ea.
DAT-31-SP(+)	Serial Interface, Single Positive Voltage	10	\$3.55
TB-334	Test Board Only	1	\$79.95